



MK Aluminum



www.cnaluprofile.com

Email: cnaluprofile@163.com

Cell phone: +86 13651855050

Address: No.108 chexin road, songjiang district,
201611, shanghai, p, r, china

Category

Index

T slot
fasteners

page 4to6



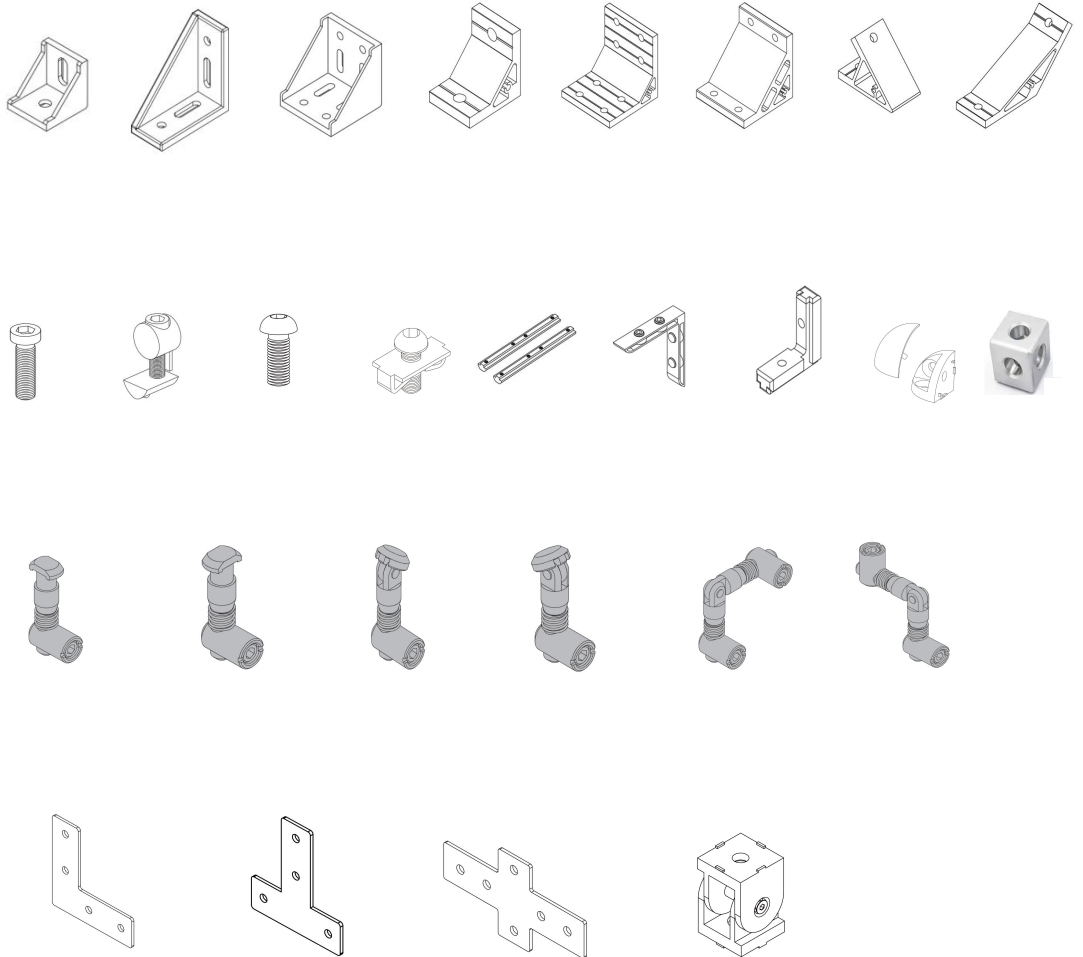

T slot
connectors

page 7to13

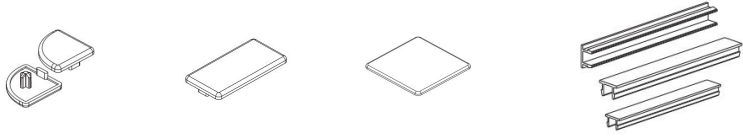
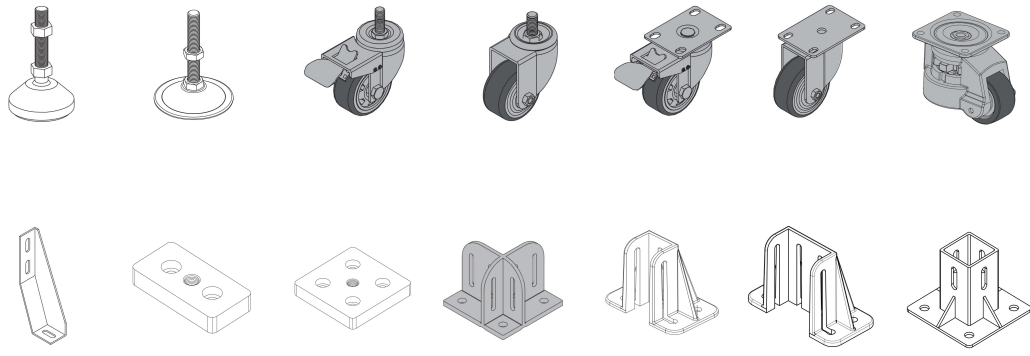
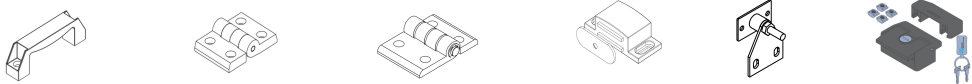
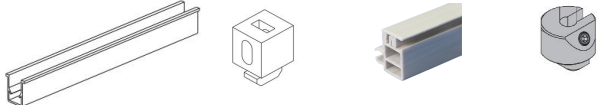

Category

Index	
<p>T slot accessories</p> <p>page 14</p>	
<p>Floor to Frame parts</p> <p>page 15to16</p>	
<p>Door & window parts</p> <p>page 17</p>	
<p>Panel mounting parts</p> <p>page 18</p>	
<p>Others</p> <p>page 19</p>	

一、T slot fasteners

1	Material
Drop in T nut	carbon steel & galvanized - C
	Stainless Steel - SS

Assembly diagram

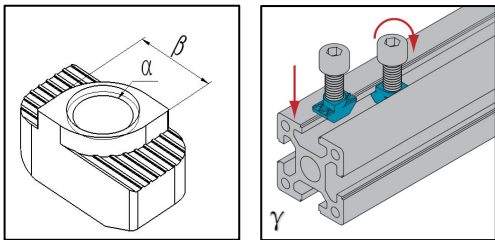

MKTSF-HHN-C - α - β - γ

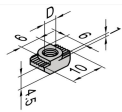

MKTSF-HHN-C (SS) -M4-6-20
 MKTSF-HHN-C (SS) -M5-6-20
 MKTSF-HHN-C (SS) -M5-6-3030G

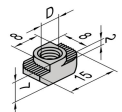

MKTSF-HHN-C (SS) -M4-8-30
 MKTSF-HHN-C (SS) -M4-8-40
 MKTSF-HHN-C (SS) -M5-8-30
 MKTSF-HHN-C (SS) -M5-8-40
 MKTSF-HHN-C (SS) -M6-8-30
 MKTSF-HHN-C (SS) -M6-8-40

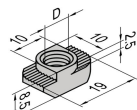

MKTSF-HHN-C (SS) -M4-10-45
 MKTSF-HHN-C (SS) -M5-10-45
 MKTSF-HHN-C (SS) -M6-10-45
 MKTSF-HHN-C (SS) -M8-10-45

2	Material
Sliding nut	carbon steel & galvanized - C
	Aluminum alloy & anodized - A

Assembly diagram

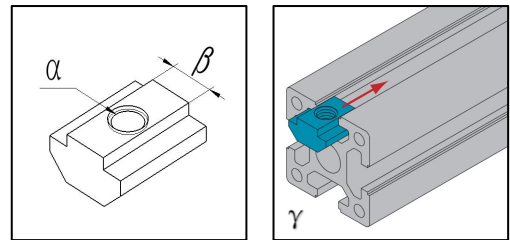

MKTSF-SN-C - α - β - γ

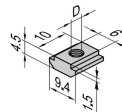

MKTSF-SN-C (A) -M4-6-20
 MKTSF-SN-C (A) -M5-6-20
 MKTSF-SN-C (A) -M6-6-20

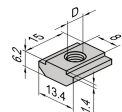

MKTSF-SN-C (A) -M5-8-30
 MKTSF-SN-C (A) -M6-8-30
 MKTSF-SN-C (A) -M8-8-30
 MKTSF-SN-C (A) -M5-8-40
 MKTSF-SN-C (A) -M6-8-40
 MKTSF-SN-C (A) -M8-8-40

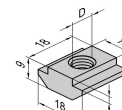

MKTSF-SN-C (A) -M4-10-45
 MKTSF-SN-C (A) -M5-10-45
 MKTSF-SN-C (A) -M6-10-45
 MKTSF-SN-C (A) -M8-10-45

3	Material
Spring ball roll in nut	Carbon steel & galvanized - C
	ADC12 die cast - A

Assembly diagram

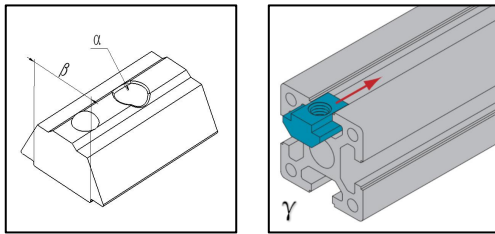

MKTSF-SRIN-C- α - β - γ

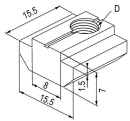

- MKTSF-SRIN-C (A) -M4-8-30
- MKTSF-SRIN-C (A) -M5-8-30
- MKTSF-SRIN-C (A) -M6-8-30
- MKTSF-SRIN-C (A) -M8-8-30
- MKTSF-SRIN-C (A) -M4-8-40
- MKTSF-SRIN-C (A) -M5-8-40
- MKTSF-SRIN-C (A) -M6-8-40
- MKTSF-SRIN-C (A) -M8-8-40

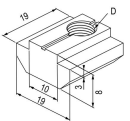

- MKTSF-SRIN-C (A) -M5-10-45
- MKTSF-SRIN-C (A) -M6-10-45
- MKTSF-SRIN-C (A) -M8-10-45
- MKTSF-SRIN-C (A) -M10-10-45

4	Material
Spring leaf roll in nut	Carbon steel & galvanized - C

Assembly diagram

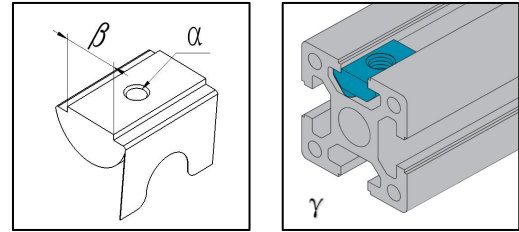

MKTSF-SRINTAB-C- α - β - γ

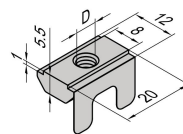

- MKTSF-SRINTAB-C-M4-8-30
- MKTSF-SRINTAB-C-M5-8-30
- MKTSF-SRINTAB-C-M6-8-30
- MKTSF-SRINTAB-C-M4-8-40
- MKTSF-SRINTAB-C-M5-8-40
- MKTSF-SRINTAB-C-M6-8-40
- MKTSF-SRINTAB-C-M8-8-40

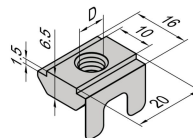

- MKTSF-SRINTAB-C-M5-10-45
- MKTSF-SRINTAB-C-M6-10-45
- MKTSF-SRINTAB-C-M8-10-45
- MKTSF-SRINTAB-C-M10-10-45

5	Material
Drop in T bolt	Carbon steel & galvanized - C
	Stainless Steel - SS

Assembly diagram

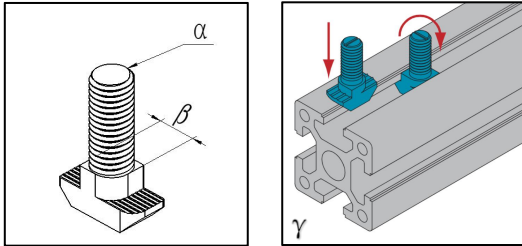

MKTSF-DITS-C- α - β - γ

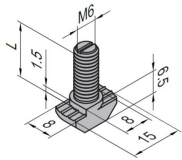

- MKTSF-DITS-C (SS)-M6*16-8-30
- MKTSF-DITS-C (SS)-M6*20-8-30
- MKTSF-DITS-C (SS)-M6*25-8-30
- MKTSF-DITS-C (SS)-M8*16-8-40
- MKTSF-DITS-C (SS)-M8*20-8-40
- MKTSF-DITS-C (SS)-M8*25-8-40
- MKTSF-DITS-C (SS)-M8*30-8-40
- MKTSF-DITS-C (SS)-M8*35-8-40
- MKTSF-DITS-C (SS)-M8*40-8-40

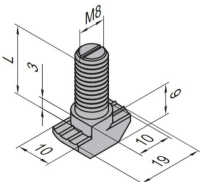

- MKTSF-DITS-C (SS)-M8*20-10-45
- MKTSF-DITS-C (SS)-M8*25-10-45
- MKTSF-DITS-C (SS)-M8*30-10-45

6	Material
Flange nut	Carbon steel & galvanized - C
	Stainless Steel - SS

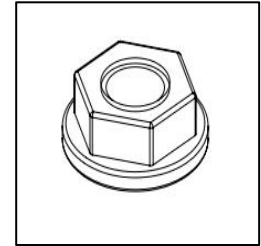
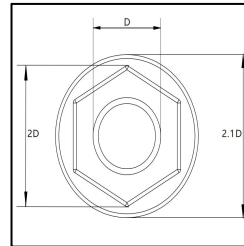

MKTSF-FN-C-D

- MKTSF-FN-C (SS)-M6
- MKTSF-FN-C (SS)-M8
- MKTSF-FN-C (SS)-M10
- MKTSF-FN-C (SS)-M12

二、T slot connectors

1	Material	Surface treatment
Die cast bracket	ADC12	Sandblast

Assembly diagram

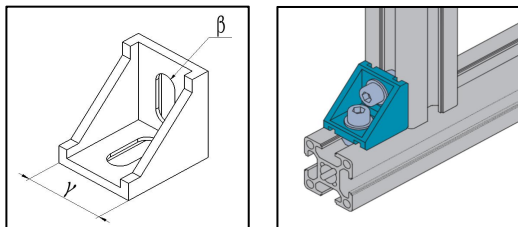

MKTSC-ADCB- γ - β



MKTSC-ADCB-2020-6



MKTSC-ADCB-3030-8

MKTSC-ADCB-4040-8



MKTSC-ADCB-4545-10

2	Material	Surface treatment
Die cast gusset bracket	ADC12	Sandblast

Assembly diagram

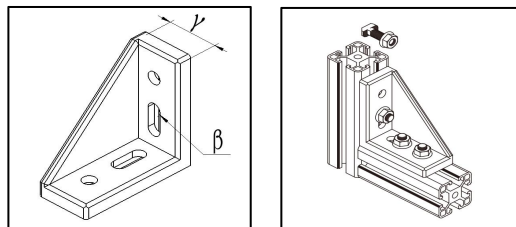

MKTSC-ADCGB- γ - β



MKTSC-ADCGB-3060-8

MKTSC-ADCGB-4080-8



MKTSC-ADCGB-4590-10

3	Material	Surface treatment
Die cast reinforce bracket	ADC12	Sandblast

Assembly diagram

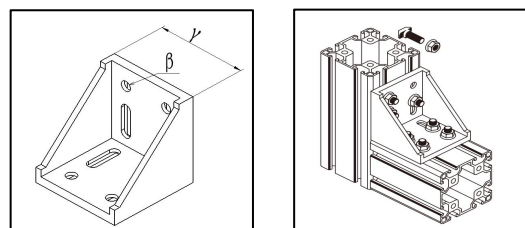

MKTSC-ADCRB- γ - β



MKTSC-ADCRB-6060-8

MKTSC-ADCRB-8080-8



MKTSC-ADCRB-9090-10

MKTSC-ADCRB-100100-10

4	Material	Surface treatment
90° Aluminum Extrusion Bracket	Aluminum Angle	Anodized

Assembly diagram

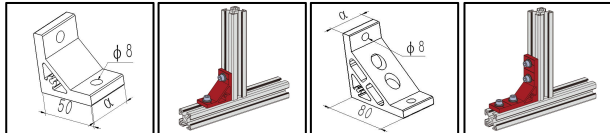

MKTSC-AEMB-α

- MKTSC-AEMB-2020
- MKTSC-AEMB-3030
- MKTSC-AEMB-4040
- MKTSC-AEMB-4545
- MKTSC-AEMB-5050

5	Material	Surface treatment
90° Aluminum Extrusion Bracket	Aluminum Angle	Anodized

Assembly diagram

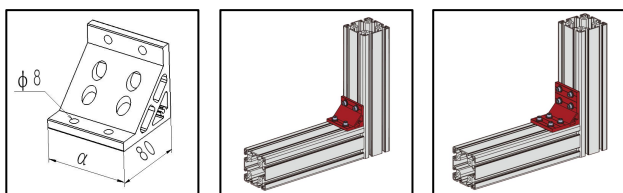

MKTSC-AEMB-α

- MKTSC-AEMB-6060
- MKTSC-AEMB-8080
- MKTSC-AEMB-9090
- MKTSC-AEMB-100100

6	Material	Surface treatment
45° Aluminum Extrusion Bracket	Aluminum Angle	Anodized

Assembly diagram

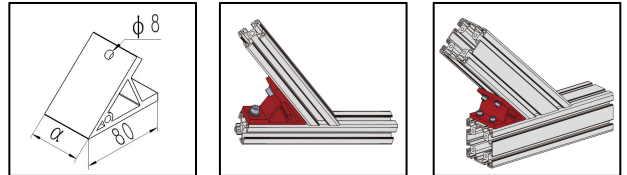

MKTSC-AEMB45-α

- MKTSC-AEMB45-2020
- MKTSC-AEMB45-3030
- MKTSC-AEMB45-3535
- MKTSC-AEMB45-4040
- MKTSC-AEMB45-5050
- MKTSC-AEMB45-6060
- MKTSC-AEMB45-8080
- MKTSC-AEMB45-9090
- MKTSC-AEMB45-100100

7	Material	Surface treatment
135° Aluminum Extrusion Bracket	Aluminum Angle	Anodized

Assembly diagram



MKTSC-AEMB135-α

- MKTSC-AEMB135-2020
- MKTSC-AEMB135-3030
- MKTSC-AEMB135-4040
- MKTSC-AEMB135-4545
- MKTSC-AEMB135-5050
- MKTSC-AEMB135-6060
- MKTSC-AEMB135-8080
- MKTSC-AEMB135-9090
- MKTSC-AEMB135-100100

8	Material
Socket Head Cap Bolt	Carbon steel & galvanized - C
	Stainless steel - SS

Assembly diagram

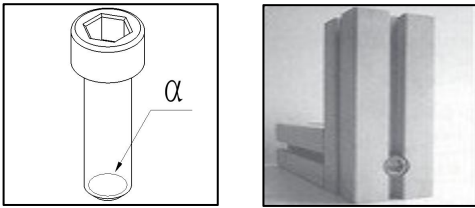

MKTSC-CHSHS-C(SS)-α

- MKTSC-CHSHS-C(SS)-M6*20
- MKTSC-CHSHS-C(SS)-M8X35
- MKTSC-CHSHS-C(SS)-M8X45
- MKTSC-CHSHS-C(SS)-M8X65
- MKTSC-CHSHS-C(SS)-M12*50-10
- MKTSC-CHSHS-C(SS)-M12*100

9	Material	Surface treatment
Anchor Fastener	Zinc Alloy	Nickle plated

Assembly diagram

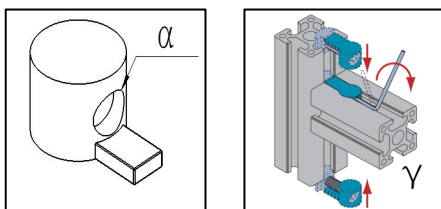

MKTSC-AFR-α-γ

- MKTSC-AFR-M6X20-30
- MKTSC-AFR-M8*25-40
- MKTSC-AFR-M8*25-45

10	Material
Socket Head Button Bolt	Carbon steel & galvanized - C
	Stainless steel - SS

Assembly diagram

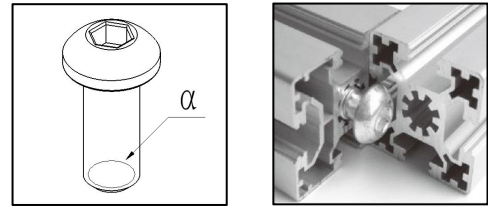

MKTSC-BHSHS-C(SS)-α

- MKTSC-BHSHS-C(SS)-M6*20
- MKTSC-BHSHS-C(SS)-M8*35
- MKTSC-BHSHS-C(SS)-M8*45
- MKTSC-BHSHS-C(SS)-M8*65
- MKTSC-BHSHS-C(SS)-M12*50-10
- MKTSC-BHSHS-C(SS)-M12*100

11	Material
Spring Fastener	Carbon steel & galvanized - C
	Stainless steel - SS

Assembly diagram

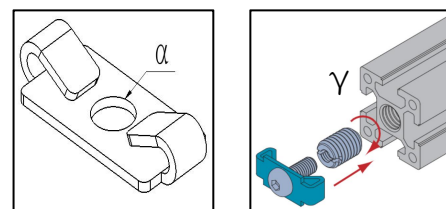

MKTSC-SF-C(SS)-α-γ

- MKTSC-SF-C(SS)-M8*20-30
- MKTSC-SF-C(SS)-M8*25-40
- MKTSC-SF-C-M12*30-45

12	Material	Surface treatment
Linear Bar Connector	Aluminum Angle	Anodized

Assembly diagram

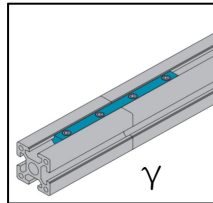
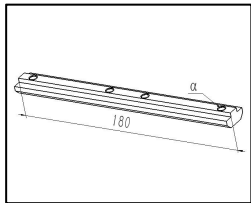

MKTSC-LBCEJ- α - γ

MKTSC-LBCEJ-M6-8-30
 MKTSC-LBCEJ-M6-8-40
 MKTSC-LBCEJ-M8-10-45

13	Material
3 Way Corner Bracket	Zinc Alloy die cast

Assembly diagram

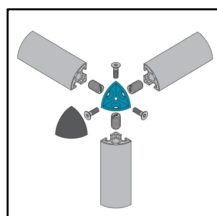
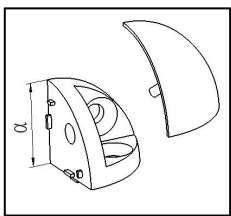

MKTSC-3DCB- α -Z

MKTSC-3DCB-3030R-Z
 MKTSC-3DCB-4040R-Z
 MKTSC-3DCB-4545R-Z

14	Material
Inner Bracket	Iron & galvanized - I
	Zinc alloy Die cast - Z

Assembly diagram

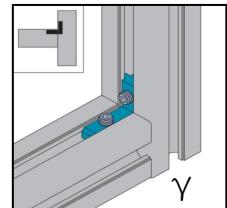
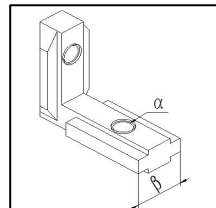

MKTSC-IB- α - β - γ -I (Z)

MKTSC-IB-M6-6-1530-I (Z)
 MKTSC-IB-M6-6-2020-I (Z)
 MKTSC-IB-M6-6-2040-I (Z)
 MKTSC-IB-M6-8-3030-I (Z)
 MKTSC-IB-M6-8-4040-I (Z)
 MKTSC-IB-M8-10-4545-I (Z)

15	Material
Cubic Corner Bracket	Zinc Alloy die cast

Assembly diagram

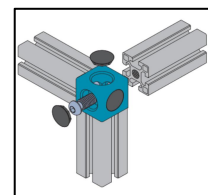
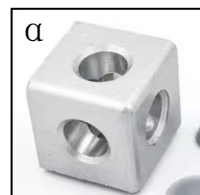

MKTSC-3CCB- α

MKTSC-3CCB-30
 MKTSC-3CCB-40
 MKTSC-3CCB-45

16	Material
Central Connector	carbon steel & galvanized

Assembly diagram

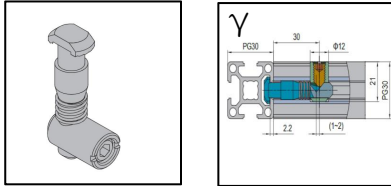

MKTSC-CC- γ (0°)

Standard

MKTSC-CC-3030 (0°)

MKTSC-CC-4040 (0°)

MKTSC-CC-4545 (0°)

18	Material
Mitered Connector	carbon steel & galvanized

Assembly diagram

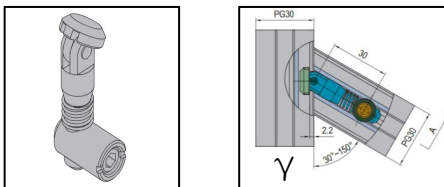

MKTSC-MCJ- γ (0°)

Standard

MKTSC-MCJ-3030 (0°)

MKTSC-MCJ-4040 (0°)

MKTSC-MCJ-4545 (0°)

17	Material
Central Connector	carbon steel & galvanized

Assembly diagram

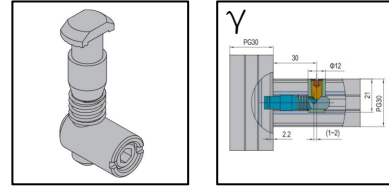

MKTSC-CC- γ (90°)

Standard

MKTSC-CC-3030 (90°)

MKTSC-CC-4040 (90°)

MKTSC-CC-4545 (90°)

19	Material
Mitered Connector	carbon steel & galvanized

Assembly diagram

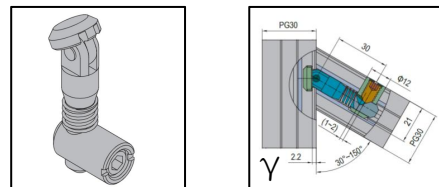

MKTSC-MCJ- γ (90°)

Standard

MKTSC-MCJ-3030 (90°)

MKTSC-MCJ-4040 (90°)

MKTSC-MCJ-4545 (90°)

20	Material
2 Way Mitered Connector	Carbon steel & galvanized

Assembly diagram

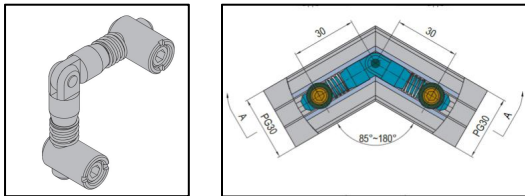

MKTSC-MCJ2W- γ (0°)

Two ways

MKTSC-MCJ2W-3030 (0°)

MKTSC-MCJ2W-4040 (0°)

MKTSC-MCJ2W-4545 (0°)

21	Material
2 Way Mitered Connector	Carbon steel & galvanized

Assembly diagram

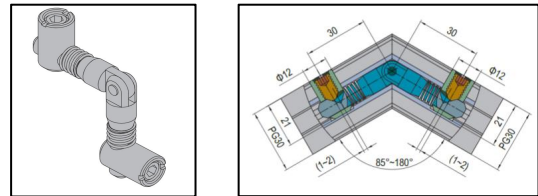

MKTSC-MCJ2W- γ (90°)

Two ways

MKTSC-MCJ2W-3030 (90°)

MKTSC-MCJ2W-4040 (90°)

MKTSC-MCJ2W-4545 (90°)

22	Material
Flat Plate	Aluminum Alloy, Anodized

Assembly diagram

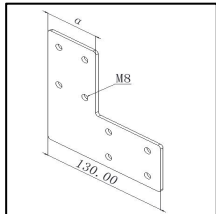
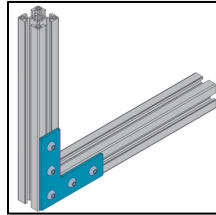
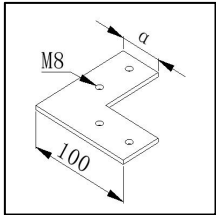

MKTSC-FJP- α -L
 MKTSC-FJP-3060-L
 MKTSC-FJP-4080-L
 MKTSC-FJP-4590-L
 MKTSC-FJP-60120-L
 MKTSC-FJP-80160-L

24	Material
Flat Plate	Aluminum Alloy, Anodized

Assembly diagram

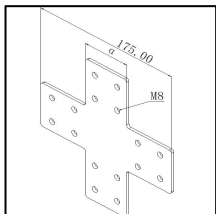
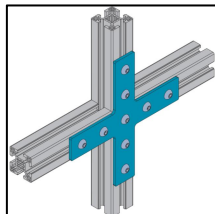
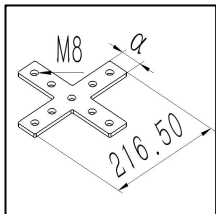

MKTSC-FJP- α -X
 MKTSC-FJP-3090-X
 MKTSC-FJP-40120-X
 MKTSC-FJP-45135-X
 MKTSC-FJP-60180-X
 MKTSC-FJP-80240-X

23	Material
Flat Plate	Aluminum Alloy, Anodized

Assembly diagram

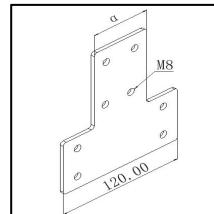
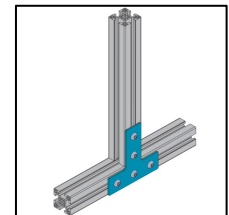
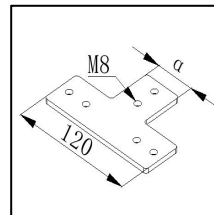

MKTSC-FJP- α -T
 MKTSC-FJP-3090-T
 MKTSC-FJP-40120-T
 MKTSC-FJP-45135-T
 MKTSC-FJP-60180-T
 MKTSC-FJP-80240-T

25	Material
Pivot Hinge	Zinc alloy

Assembly diagram

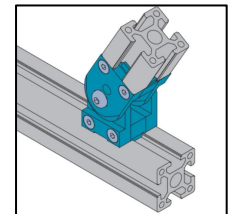
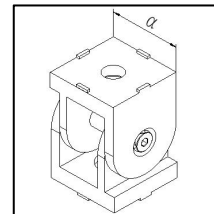

MKTSC-PHJ- α
 MKTSC-PHJ-3030
 MKTSC-PHJ-4040
 MKTSC-PHJ-4545

三、 T slot accessories

1	Material	color
End cap	pvc	Black, Grey

Assembly diagram

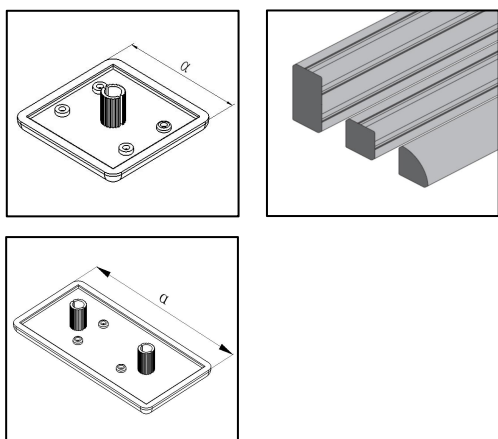

MKTSPA-EC- α -B

- MKTSPA-EC-1530-B
- MKTSPA-EC-2020-B
- MKTSPA-EC-2040-B
- MKTSPA-EC-3030-B
- MKTSPA-EC-3030R-B
- MKTSPA-EC-3060-B
- MKTSPA-EC-4040-B
- MKTSPA-EC-4040R-B
- MKTSPA-EC-4080-B
- MKTSPA-EC-4545-B
- MKTSPA-EC-4090-B
- MKTSPA-EC-9090-B
- MKTSPA-EC-5050-B
- MKTSPA-EC-6060-B
- MKTSPA-EC-8080-B

2	Material	color
T slot cover	pvc	Black, Grey

Assembly diagram

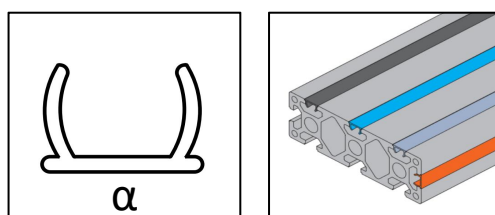

MKTSPA-TSC- α -B

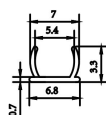

MKTSPA-TSC-6-B

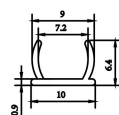

MKTSPA-TSC-8-B

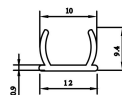

MKTSPA-TSC-10-B

四、Floor to frame parts

1	Material	Threaded rod
Nylon base levelling foot	Base: Nylon in black	Carbon steel & galvanized - C
		Stainless steel - SS

Assembly diagram

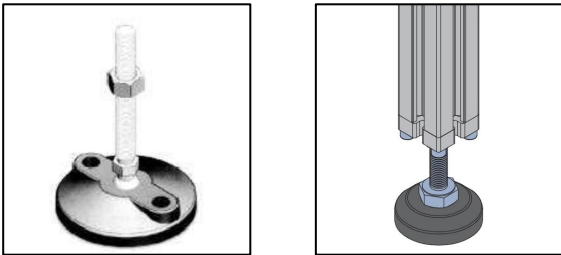

MKFP-LF-NB-D40 M8x50-C(SS)
 MKFP-LF-NB-D50 M10x80-C(SS)
 MKFP-LF-NB-D60 M12x100-C(SS)
 MKFP-LF-NB-D80 M12x150-C(SS)
 MKFP-LF-NB-D100 M16x150-C(SS)

3	Material
Thread castor	PU castor

Assembly diagram

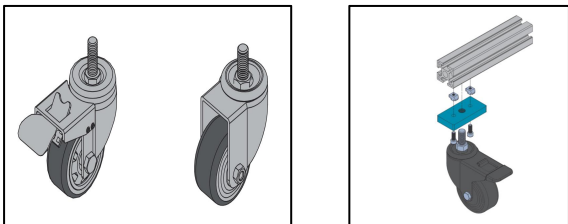

MKFP-PUTC-1.5Inch
 MKFP-PUTC-2.0Inch
 MKFP-PUTC-2.5Inch
 MKFP-PUTC-3.0Inch

2	Material	Threaded rod
Heavy load metal levelling foot	carbon steel & galvanized - C	carbon steel & galvanized - C
	Stainless steel - SS	Stainless steel - SS

Assembly diagram

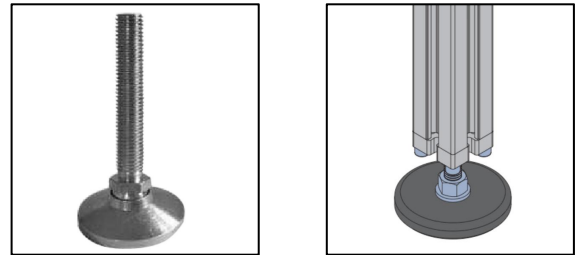

MKFP-LF-HLMLF-D40 M8x50-C(SS)
 MKFP-LF-HLMLF-D50 M10x80-C(SS)
 MKFP-LF-HLMLF-D60 M12x100-C(SS)
 MKFP-LF-HLMLF-D80 M12x150-C(SS)
 MKFP-LF-HLMLF-D100 M16x150-C(SS)

4	Material
Plate castor	PU castor

Assembly diagram

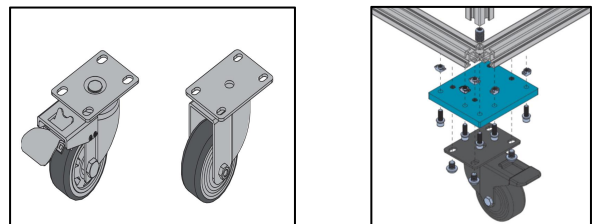

MKFP-PUPC-1.5Inch
 MKFP-PUPC-2.0Inch
 MKFP-PUPC-2.5Inch
 MKFP-PUPC-3.0Inch

5	Material
Footmaster castor	PU castor

Assembly diagram

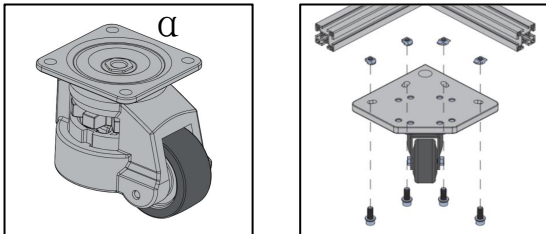

MKFP-GD- α

MKFP-GD-40F
 MKFP-GD-60F
 MKFP-GD-80F
 MKFP-GD-120F

6	Material
End Plate	Aluminum Alloy, Anodized

Assembly diagram

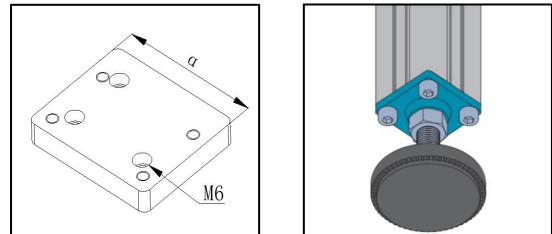

MKFP-EJP- α

MKFP-EJP-3060
 MKFP-EJP-4080
 MKFP-EJP-4590
 MKFP-EJP-6060
 MKFP-EJP-8080
 MKFP-EJP-9090

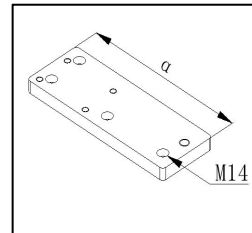

7	Material
Regular Floor Bracket	Zinc alloy, powder coated
	Carbon steel, powder coated

Assembly diagram

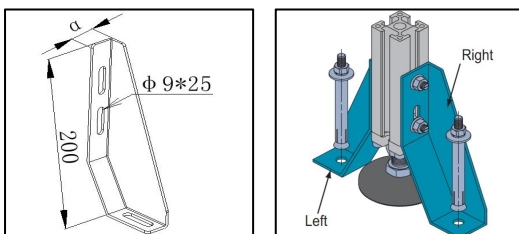

MKFP-FFS- α

MKFP-FFS-3060
 MKFP-FFS-4080
 MKFP-FFS-50100

8	Material
Reinforced Floor Bracket	Zinc alloy, powder coated
	Carbon steel, powder coated

Assembly diagram

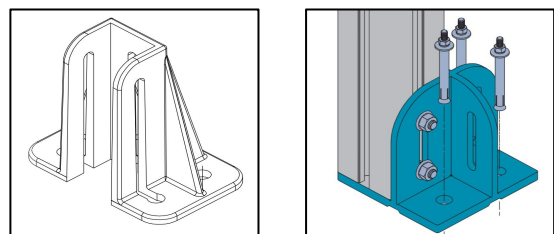

MKFP-FSFF- α

MKFP-FSFF-3060
 MKFP-FSFF-4080
 MKFP-FSFF-8080

五、 Door & window parts

1	Material
Handle	Nylon in Black - N
	Zinc alloy, powder coated in Black - Z

Assembly diagram

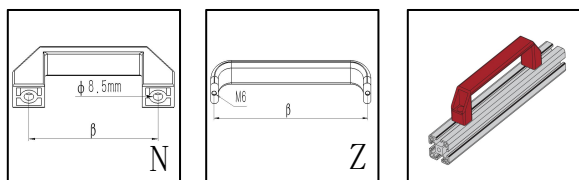

MKDWP-HL-N(Z)-β

MKDWP-HL-N(Z)-90
MKDWP-HL-N(Z)-120
MKDWP-HL-N(Z)-180

3	Material
Magnetic door catch	Stainless Steel Plastic Brass

Assembly diagram

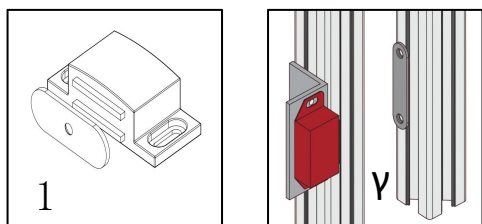

MKDWP-MDC-1 (2) - γ

MKDWP-MDC-1 (2) -20
MKDWP-MDC-1 (2) -30
MKDWP-MDC-1 (2) -40
MKDWP-MDC-1 (2) -45

2	Material
Hinge	Nylon in Black - N
	Zinc alloy, powder coated in Black - Z
	Aluminum Alloy, anodized - A

Assembly diagram

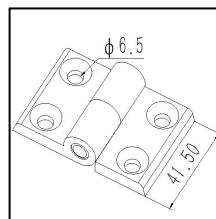
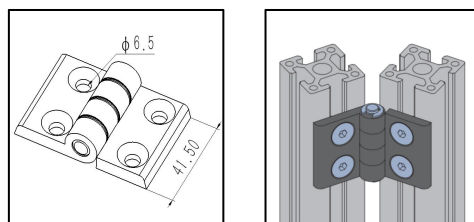

MKDWP-HG-N (Z, A) -B-2020
MKDWP-HG-N (Z, A) -B-3030
MKDWP-HG-N (Z, A) -B-4040
MKDWP-HG-N (Z, A) -B-4545

4	Material
Lock	Stainless Steel Plastic Brass

Assembly diagram

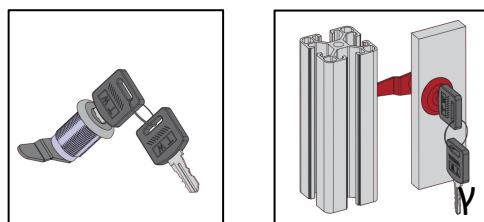

MKDWP-LK-γ

MKDWP-LK-20
MKDWP-LK-30
MKDWP-LK-40
MKDWP-LK-45

六、Panel mounting parts

1	Material
Panel mounting strip	PVC

Assembly diagram

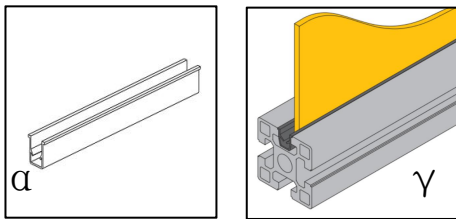

MKPMP-PMSP- α - γ

MKPMP-PMSP-6-1530
 MKPMP-PMSP-8-30
 MKPMP-PMSP-8-40
 MKPMP-PMSP-10-45

3	Material
Panel mounting Bar	PVC

Assembly diagram

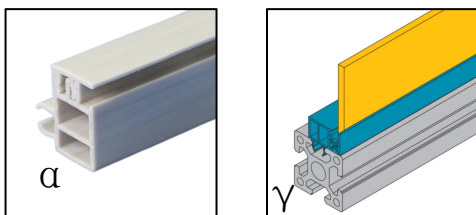

MKPMP-PMBS- α - γ

MKPMP-PMBS-8-30
 MKPMP-PMBS-8-40
 MKPMP-PMBS-10-45

2	Material
Panel mounting block	PVC

Assembly diagram

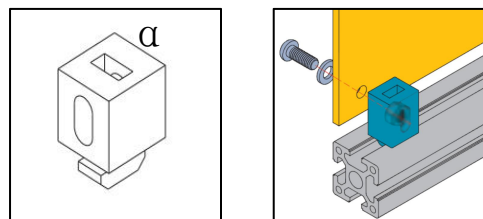

MKPMP-PMBC- α

MKPMP-PMBC-30
 MKPMP-PMBC-40
 MKPMP-PMBC-45

4	Material
Wire mesh mounting block	Carbon steel & galvanized - C

Assembly diagram

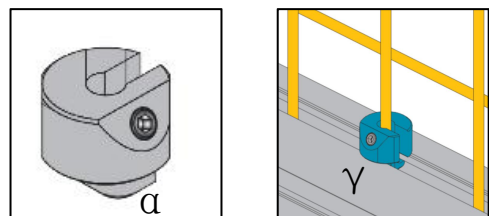

MKPMP-WMMB- α - γ -C

MKPMP-WMMB-8-30-C
 MKPMP-WMMB-8-40-C
 MKPMP-WMMB-10-45-C

七、Others

1	Material
Slide hook	Nylon black-N Alu diecast -ADC

Assembly diagram

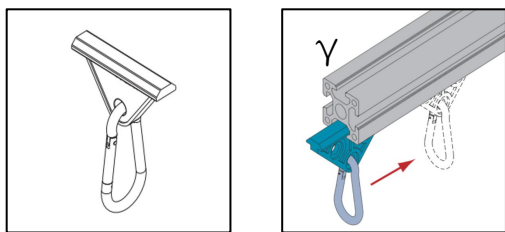

MKOS-SH-N- γ

MKOS-SH-N-20
MKOS-SH-N-30
MKOS-SH-N-40
MKOS-SH-N-45

3	Material
Eye-Bolt	Carbon Steel Galvanized

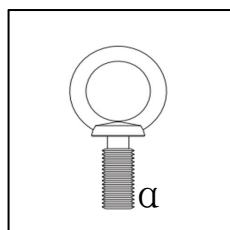

MKOS-MB- α

MKOS-MB-M8
MKOS-MB-M10
MKOS-MB-M12

2	Material
Swivel Connecting plate	Carbon Steel Surface pawdercoat

Assembly diagram

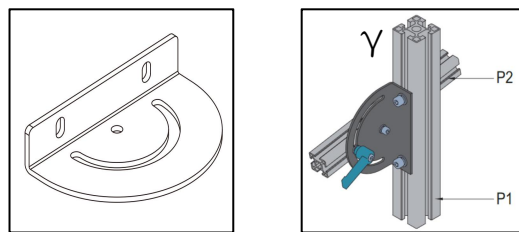

MKOS-SP- γ

MKOS-SP-30
MKOS-SP-40
MKOS-SP-45



Shanghai MK Aluminium Products Co.,Ltd
Australia MK Group Pty Ltd
Jiangsu MKDR Aluminum Co.,Ltd

Cell +86-13651855050
www.cnaluprofile.com
Email: cnaluprofile@163.com